

**APPLICATIONS**

- Uninterruptible Power Supplies (UPS)
- Electric Power Systems (EPS)
- Emergency backup power supplies
- Electronic apparatus and equipment
- Communication power supplies
- DC power supplies
- Auto control system

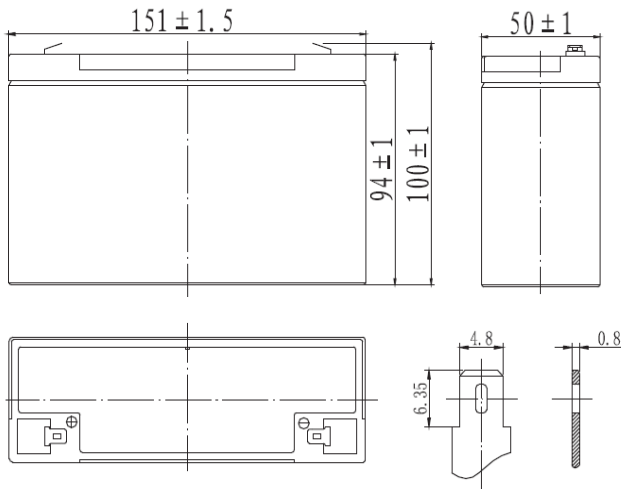

**SPECIFICATIONS**

Nominal Voltage	6 V	
Number of cells	3	
Design Floating Life (20°C)	10 years	
Dimensions	Length	151 mm
	Width	50 mm
	Height	94 mm
	Total Height	100 mm
Weight	1.74 kg	
Nominal Capacity (25°C)	20 hours rate (1.75)	12.0 Ah
	10 hours rate (1.75)	11.3 Ah
	5 hours rate (1.75)	10.2 Ah
	1 hour rate (1.65)	7.74 Ah
Internal Resistance (fully charged, 25°C)	10 mOhm	
Self Discharge	approx. 3% per month at 25°C	
Nominal Operating Temperature	25°C	
Operating Temperature range	Discharge	-15°C to 45°C
	Charge	0°C to 40°C
	Storage	-15°C to 40°C
Float Charging Voltage	2.27 to 2.30 V/cell at 25°C	
Temperature compensation	-10mV/°C	
Maximum charging current	3.6 A	
Maximum discharge current (25°C)	120 A (5 sec.)	
Short Circuit Current (25°C)	180 A	

**PERFORMANCE DATA**

**Discharge Constant Current at 25°C (Amperes)**

End Voltage (V/cell)	5min	10min	15min	30min	1h	2h	3h	4h	5h	8h	10h	20h
1.60V	46.9	29.2	23.0	13.1	7.85	4.30	3.14	2.51	2.17	1.40	1.14	0.64
1.65V	44.2	28.2	22.5	12.8	7.74	4.28	3.12	2.49	2.13	1.37	1.14	0.64
1.70V	42.5	27.1	21.6	12.2	7.51	4.24	3.10	2.48	2.08	1.34	1.13	0.63
1.75V	40.6	25.9	20.9	11.9	7.37	4.18	3.08	2.46	2.04	1.33	1.13	0.60
1.80V	38.4	24.7	19.8	11.5	7.15	4.07	2.98	2.39	1.99	1.29	1.10	0.59

**Discharge Constant Power at 25°C (Watts/Cell)**

End Voltage (V/cell)	5min	10min	15min	30min	1h	2h	3h	4h	5h	8h	10h	20h
1.60V	84.9	54.7	43.5	24.4	15.1	8.34	6.19	4.94	4.23	2.72	2.27	1.25
1.65V	82.7	53.0	42.6	24.0	14.9	8.31	6.15	4.91	4.15	2.69	2.27	1.24
1.70V	79.0	50.9	40.8	23.2	14.5	8.23	6.14	4.87	4.12	2.67	2.25	1.24
1.75V	75.7	50.7	39.5	22.6	14.2	8.11	6.00	4.84	4.08	2.65	2.25	1.23
1.80V	71.4	47.6	37.4	21.9	13.8	7.89	5.82	4.70	3.96	2.57	2.19	1.20

Note: The above characteristics data can be obtained within three charge/discharge cycles.

**Temperature Effects on Float Life**

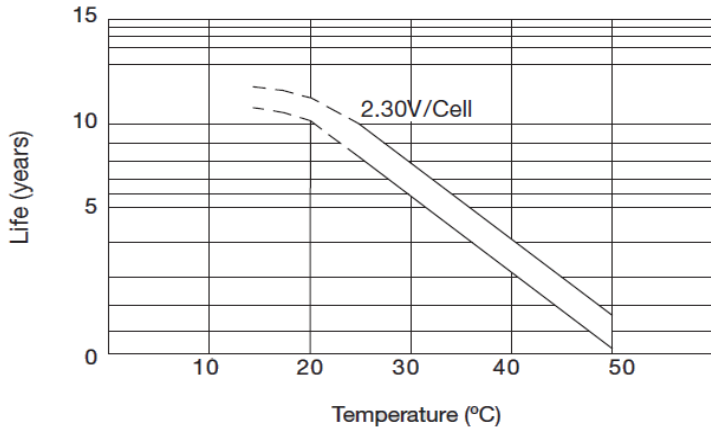

**Self Discharge Characteristics**

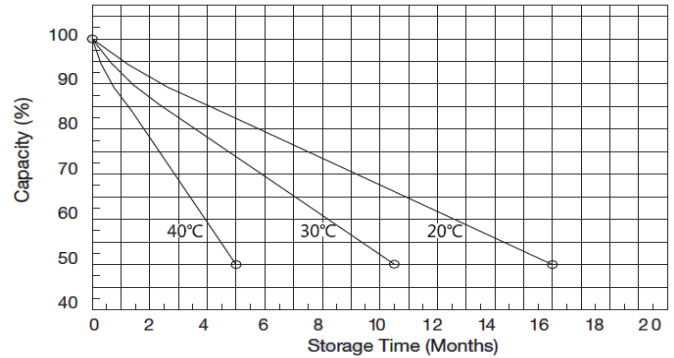

**Discharge Characteristics (25°C)**

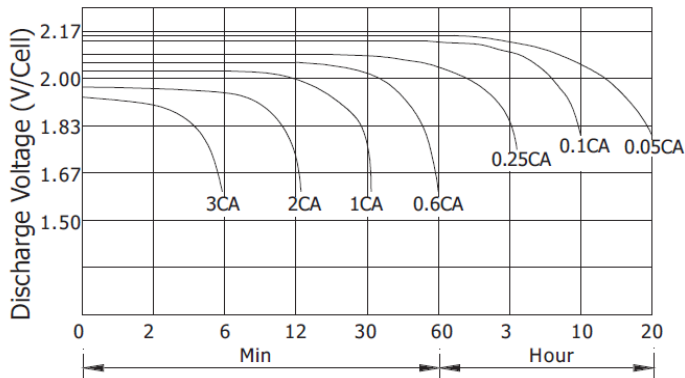

**Charging Characteristics (25°C)**

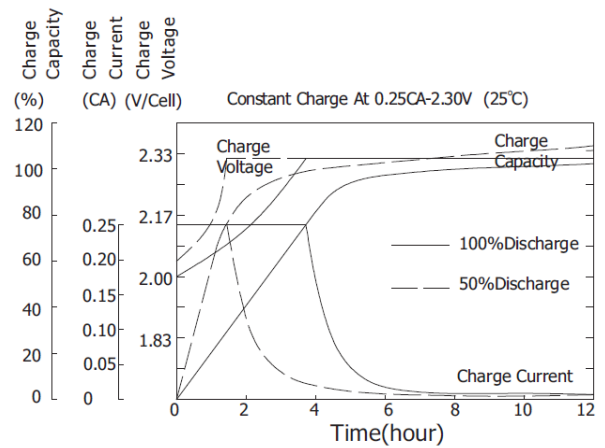

**Cycle Service Life in Relation to Depth of Discharge**

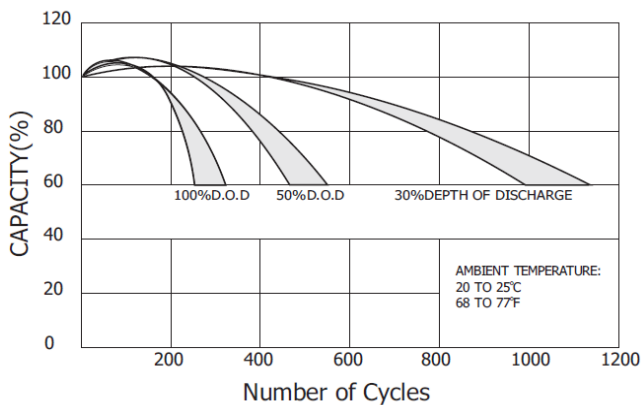

**Relationship Between OCV and Residual Capacity (25°C)**

